

XR 500 HPL

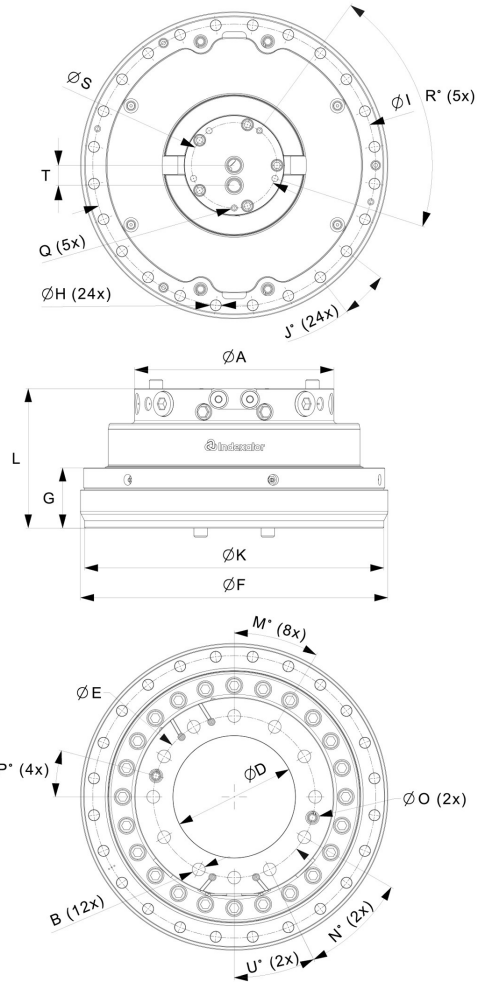

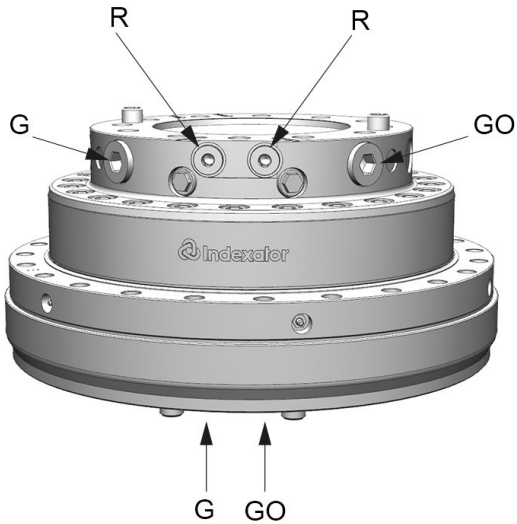







Part No.: 8500002



Upper

G GO:	R:
G 1	G 1/2

A: Ø326 mm	B: M24	C: 37 mm	D: Ø200 mm	E: Ø265 mm	F: Ø503 mm	G: 98,5 mm	H: Ø17,5 mm	I: Ø463 mm	J: 15°	K: Ø490 mm	L: 228,5 mm	M: 30°	N: 34°
O: Ø22 mm	P: 15°	Q: M12	R: 72°	S: Ø140 mm	T: 33 mm	U: 26°							

									
216 kg	360°	±700 kN	±250 kN	±180 kN	7000 Nm	40 l/min	25 MPa	35 MPa	35 MPa

Oil distributor ordered separately

Pressure limiting valves fitted.

For further technical information relating to integration and hydraulic connections, please contact rotator@indexator.com